

WIDEPIX[®] 2(1)x5

Version 1.0 - Datasheet

Model No.: W25xRS-Xxx170307

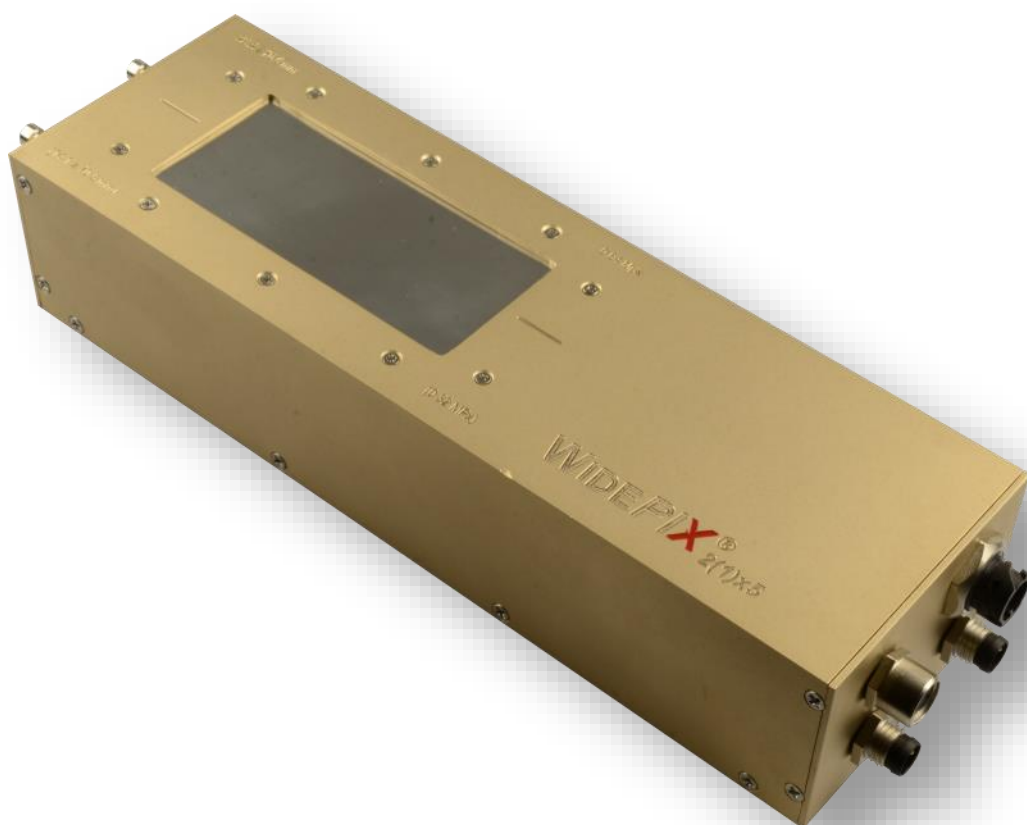

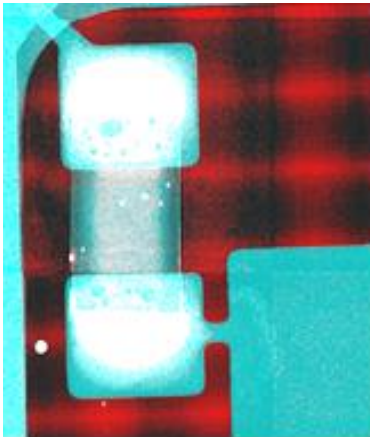
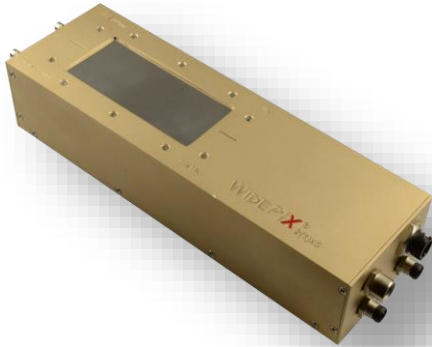

The large area imaging detector **WIDEPIX_{2(1)x5}** with resolution of 512 (256) x 1280 pixels i.e. 0.64 (0.32) Mpixels and continuously sensitive surface is composed of a row of detector tiles. Each tile consists of a single Timepix hybrid detector (256 x 256 pixels) with an edgeless silicon or CdTe sensor. Thus the whole area of the **WIDEPIX_{2(1)x5}** device is fully sensitive. Each pixel has integrated digital counter that counts number of particles e.g. X-ray photons. The particle counting principle assures a noiseless detection with no additional noise due to image integration or readout. The noiseless detection allows getting X-ray images with very high contrast and broad dynamic range. Therefore, even structure of low attenuating objects, such as plastic or soft tissue, is imaged with a high contrast.

The arrangement of tiles in the row is very advantageous for larger object imaging. The **WIDEPIX_{2(1)x5}** moreover supports a hardware based Time-Delayed-Integration mode for online (continuous) scanning applications. Both devices are suitable for CT scanners, which can take advantage of large sensitive area without any gaps.

The Timepix technology allows setting of energy threshold. This feature allows obtaining multichannel "color" radiographs where different materials are identified and imaged in different colors (similar to color photography). This feature requires getting of several (at least two) subsequent snapshots with different settings of the energy threshold. The minimum energy threshold is typically better than 5 keV. The intrinsic spatial resolution of the camera is defined by the pixel size, which is 55 µm. The pixels situated on the border of tiles are 2.5 times larger in one direction. The corner pixels of tiles are 2.5 times larger in both directions.

The camera is connected to the controlling computer via USB 2.0 cable. The readout time is 50 (25) ms per frame resulting in maximal speed of 20 (40) frames per second.

Main Features:

- Readout chip type..... Timepix
- Sensor material.....300, 500 µm thick Si or 1000 µm thick CdTe
- Pixel size55 x 55 µm
- Sensor resolution.....256 x 1280 pixels (1x5) | 512 x 1280 pixels (2x5)
- Dynamic range in one frame11 810¹
- Time-Delayed-Integration mode.....YES (1x5) | NO (2x5)
- Interface.....USB 2.0
- Maximum frame rate..... 40 fps (1x5) | 20 fps (2x5)
- Dimensions213 x 60 x 40 mm
- Weight1700 g (1x5) | 1800 g (2x5)
- Dark Current.....none

¹ This value corresponds to the depth of counter in pixels. A higher number of counts are measured by summing multiple images. Thus, an arbitrary dynamic range could be achieved.



Device Parameters

Operating Conditions

Symbol	Parameter	Min	Typ	Max	Units	Comment
TA	Ambient Temperature Range	0	30	40	°C	Max with heat sink
Φ	Humidity			60	%	Not condensing
	IP Code		IP50			

Family Parameters

TA = 25°C, USB voltage VCC = 24V

Symbol	Parameter	WidePIX 1x5	WidePIX 2x5	Units	Comment
VCC	Supply Voltage	20/24/26		V	
ICC	Supply Current (VCC = 24V)	400	700	mA	
P	Power Dissipation	9	16	W	
	Sensitive Area	71.5 x 14.1	71.5 x 28.2	mm	
	Detector Resolution	256 x 1280	512 x 1280	Pixels	
	Frame Rate	40	20	fps	
	Readout Time	25	50	ms	
	Weight	1700	1800	g	

Sensor parameters

TA = 25°C

Symbol	Parameter	Si			CdTe	Units	Comment
	Thickness	100	300	1000	1000	µm	
	Bias Voltage	50	200	500	-500	V	Max
	Calibrated in X-ray Energy Range						See chart below
	Energy resolution						
	Detectable energy range	5 to 60			5 to 600	keV	

X-ray attenuation in Silicon and CdTe

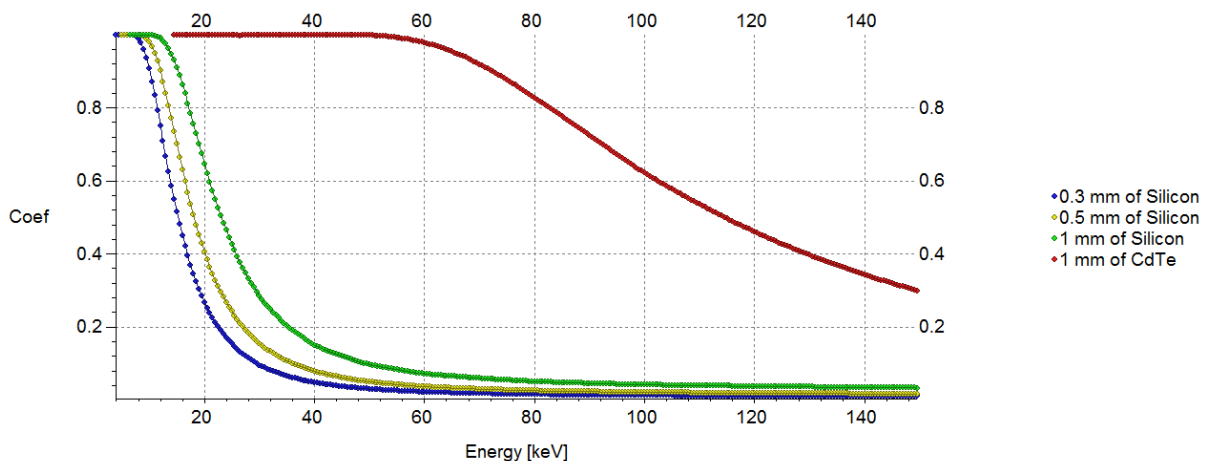

Device Description

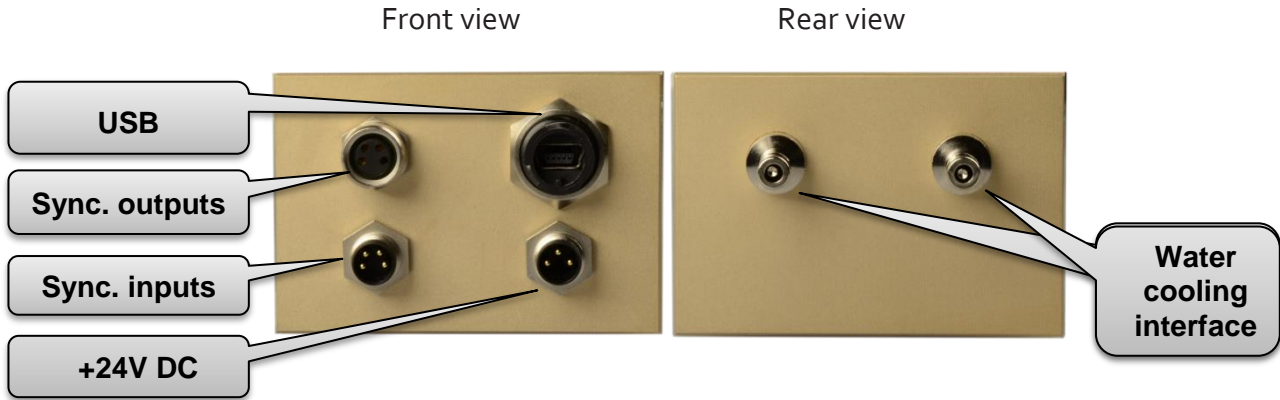

+24VDC connector

Main power supply (via standard M8 connector with 3 female contacts). Connect after plugging USB connector.

USB connector

USB type micro B, Standard USB 2.0 Hi-Speed, In IP68 protection.

Synchronization interface

Connector Two 4-pin M8 connectors (female for outputs and male for input) serve as synchronization interface, allowing to synchronize **WIDEPIX_{2(1)x5}** detector with external processes. Four signals are available:

- Ready in – measurement is not possible, when signal at logical zero
- Trigger in – logical zero starts shutter (measurement)
- Ready out – logical one if device is ready to for new shutter
- Trigger out – mirrors shutter (logical zero when shutter is active)

All signals are TTL compatible and 5V tolerant. For detailed description see **Synchronization Guide**.

Sync. Outputs (M8-4 Female)		Sync. Inputs (M8-4 Male)	
Pin	Signal	Pin	Signal
1	Gnd	1	Gnd
2	Ready out	2	Ready out
3	Trigger out	3	Trigger out
4	Reserved	4	Reserved

Water cooling interface

It is mandatory to cool down detector when in operation. **WIDEPIX_{2(1)x5}** uses water connectors that allow for quick disconnection/reconnection. Mating connector is included as standard accessories and has to be attached to 4x6mm plastic hose.

Mechanical Dimensions

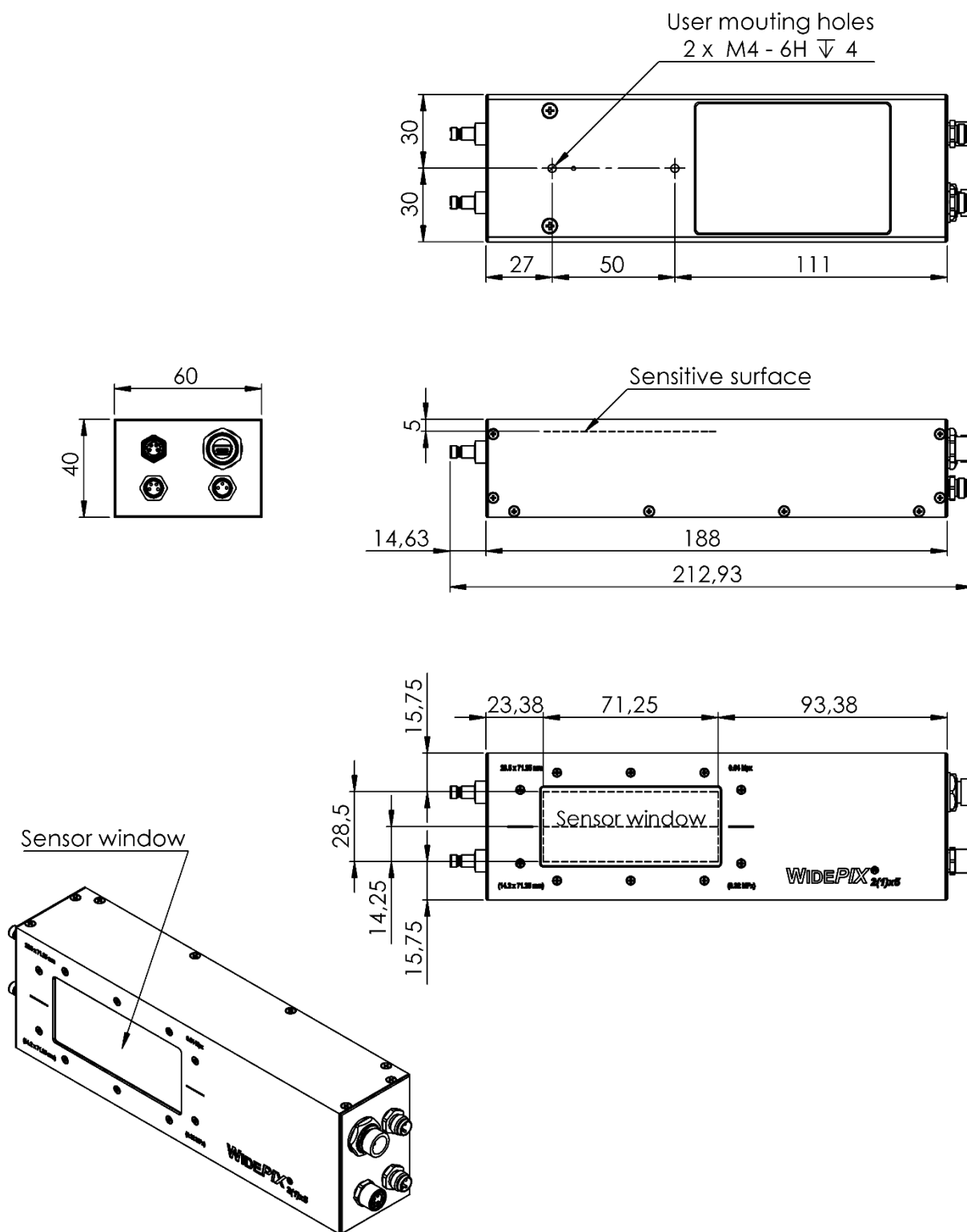

All dimensions are in mm.



Sensitive area

Sensitive area for **WIDEPIX**_{1x5}

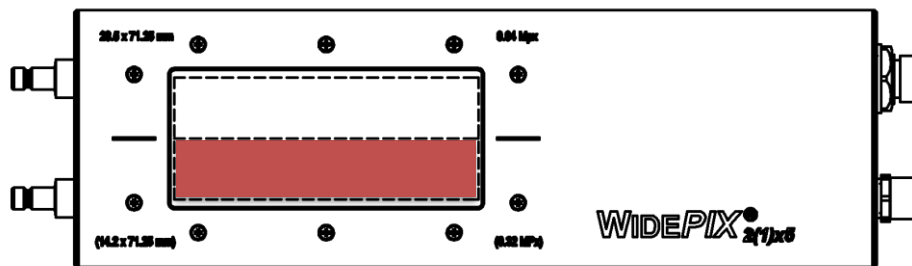

Sensitive area for **WIDEPIX**_{2x5}

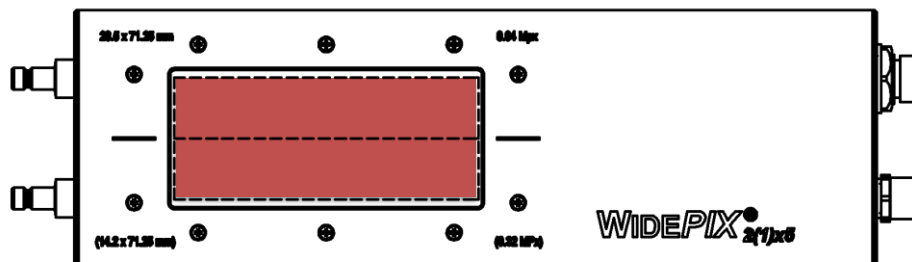



Model number codes

Example:

W25 1RS - X C A 170307

Device name:

W25 – WidePIX 2(1)x5

Device modification:

1RS – 1x5 Timepix chips
2RS – 2x5 Timepix chips

Sensor type:

E – Edgless silicon
C – CdTe

Sensor thickness:

1 – 100 µm
3 – 300 µm
5 – 500 µm
A – 1000 µm

Device version date:

YY MM DD

Release history

Date	Changes
17/11/02	Model number codes added, datasheet version
17/11/24	Power consumption updated



Warning

Do not touch sensor surface!

Instructions for safe use.

To avoid malfunction or damage to your **WIDEPIX** 2(1)x5 please observe the following:

- Do not expose to water, moisture **WIDEPIX** 2(1)x5 is dust protected only.
- Do not open **WIDEPIX** 2(1)x5 case. Detectors wire-bonding connections may be irreversibly damaged.
- Do not operate detector when not properly water cooled. Otherwise detector temperature may rise above specified range.

Disclaimer: ADVACAM s.r.o. its affiliates, agents, and employees, and all persons acting on its or their behalf, disclaim any and all liability for any errors, inaccuracies or incompleteness contained in any datasheet or in any other disclosure relating to any product.

Copyright

ADVACAM s.r.o.

U Pergamenky

1145/ 12, 170 00

Czech Republic

Tel: +420 603 444 112

Email:

info@advacam.cz

www.advacam.com

